

EVOLVE² 30



User manual

© 2021 GN Audio A/S. All rights reserved. Jabra® is a trademark of GN Audio A/S.

Made in China
MODEL: HSC140

Declaration of Conformity can be found on
www.jabra.com/doc

1. Welcome.....	4
2. Jabra Evolve2 30 overview.....	5
2.1 Included accessories	
3. How to connect.....	6
3.1 Connect to computer	
3.2 Connect to mobile devices	
4. How to wear	8
4.1 Wearing styles	
4.2 Adjusting the headset	
5. What the LEDs mean	10
6. How to use	11
6.1 Calls & music	
6.2 Sidetone	
6.3 Voice guidance	
6.4 Multiple call handling	
7. Software and firmware	16
7.1 Jabra Direct	
7.2 Update firmware	
8. Support	17
8.1 FAQ	
8.2 How to care for your headset	

1. Welcome

Thank you for using the Jabra Evolve2 30. We hope you will enjoy it!

Jabra Evolve2 30 features

- 2-microphone call technology
- Designed for all-day comfort
- Built-in Busylight
- 28mm speaker for exceptional sound

2. Jabra Evolve2 30 overview

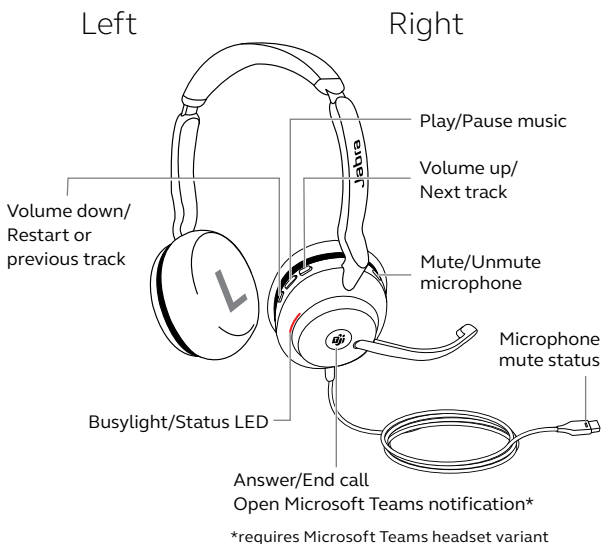

2.1 Included accessories

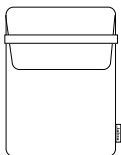

Carry pouch

3. How to connect

3.1 Connect to computer

Plug the Jabra Evolve2 30 into either a USB-A or USB-C port on your computer, depending on the USB variant of the headset.

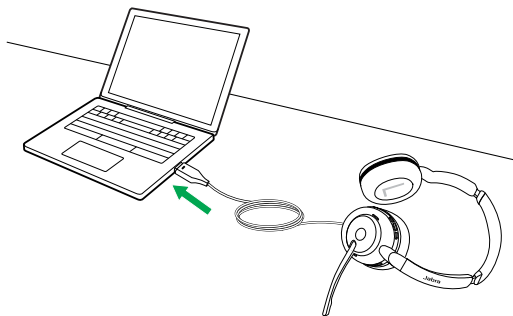

3.2 Connect to mobile devices

Plug the Jabra Evolve2 30 into a USB-C port on your mobile device. Not all USB-C devices or apps support an audio connection to the Jabra Evolve2 30.



4. How to wear

4.1 Wearing styles

Mono variant

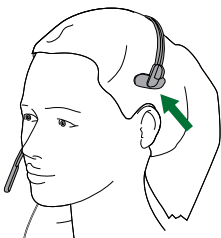

Stereo variant

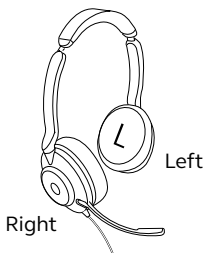

4.2 Adjusting the headset

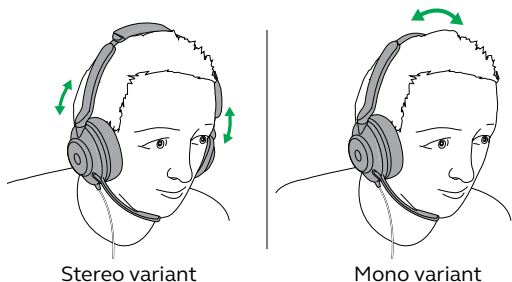

While wearing the headset, adjust the headband so that it fits your head comfortably.

When using the microphone, it should be positioned close to your mouth.

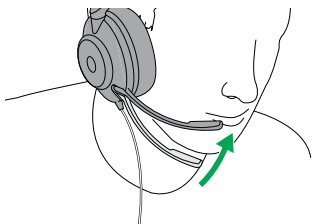

5. What the LEDs mean

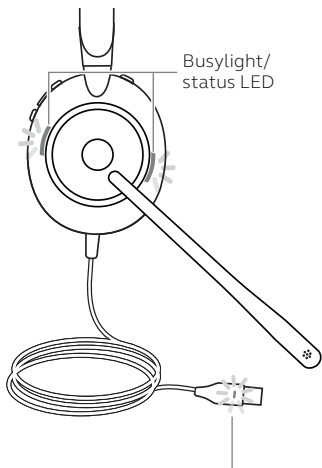

Busylight/
status LED

BUSYLIGHT/STATUS LED

- Busylight
- Incoming call
- Plugged into computer and signed into Microsoft Teams*
- Headset is trying to connect to Microsoft Teams. Will time out after 10 seconds*
- Microsoft Teams notification*

MUTE STATUS LED

- Headset microphone muted

*requires Microsoft Teams headset variant

6. How to use

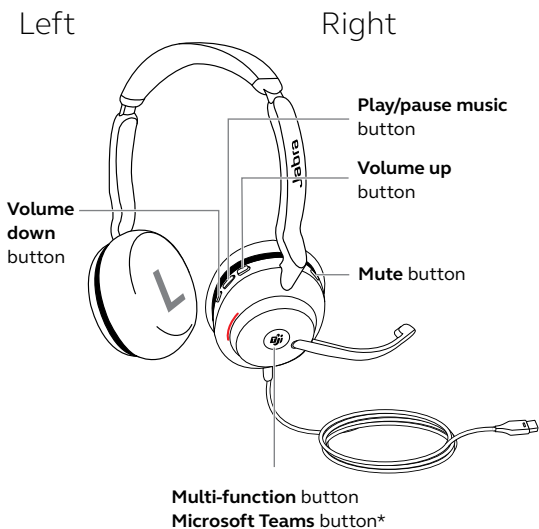

*requires Microsoft Teams headset variant

6.1 Calls & music

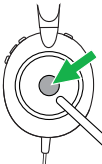
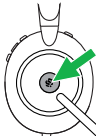
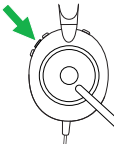
Right	Calls and music	
	Answer call	Press the Multi-function button
	End call	Press the Multi-function button
	Reject call	Double-press the Multi-function button
	Bring Microsoft Teams to foreground on computer	Press the Microsoft Teams button* (when signed into Microsoft Teams)
	Join active Microsoft Teams meeting	Press the Microsoft Teams button* (when signed into Microsoft Teams)
	View Microsoft Teams missed calls and voicemails	Press the Microsoft Teams button* (when signed into Microsoft Teams)
	Play/pause music	Press the Play/pause music button

*requires Microsoft Teams headset variant

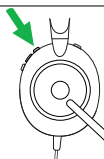

Raise volume

Press the **Volume up** button

Next track

Press and hold (1 sec) the **Volume up** button

Lower volume

Press the **Volume down** button

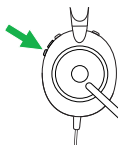

Restart track

Press and hold (1 sec) the **Volume down** button to restart the current track.

Press and hold twice to play the previous track.

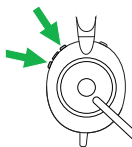

Busylight on/off

Press the **Volume up** and **Volume down** buttons at the same time



Mute/unmute microphone

Press the **Mute** button, when on a call.

Alternatively, move the microphone boom-arm up to mute, or down to unmute.

6.2 Sidetone

Sidetone enables you to better hear your own voice when you are on a call.

Sidetone settings can be configured using Jabra Direct.

6.3 Voice guidance

Voice guidance are announcements that will guide you through set up, or will give you headset status updates (e.g. mute status).

Right	Voice guidance
	<p>Turn Voice guidance on/off</p> <p>Press and hold (5 sec) the Mute button and the Volume up button until you hear an announcement</p>

Alternatively, use Jabra Direct to turn Voice guidance on or off.

6.4 Multiple call handling

The headset can accept and handle multiple calls at the same time.

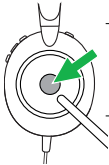
Right	Multiple call handling	
	End current call and answer incoming call	Press the Multi-function button
	Put current call on hold and answer incoming call	Hold (2 secs) the Multi-function button
	Switch between held call and active call	Hold (2 secs) the Multi-function button
	Activate Cortana	Hold (2 secs) the Microsoft Teams button*
	Reject incoming call, when on a call	Double-press the Multi-function button

*requires Microsoft Teams headset variant

7. Software and firmware

7.1 Jabra Direct

Jabra Direct is computer software designed to support, manage and enable optimal functionality for Jabra devices.

Download the latest free version from jabra.com/direct

7.2 Update firmware

Firmware updates improve performance or add new functionality to Jabra devices.

1. Connect the Jabra Evolve2 30 to a computer.
2. Use Jabra Direct to check for the latest firmware updates.

8. Support

8.1 FAQ

View the FAQs on [Jabra.com/help/evolve2-30](https://www.jabra.com/help/evolve2-30).

8.2 How to care for your headset

- Always store the headset in the supplied pouch.
- Avoid storage at extreme temperatures (above 55°C/131°F or below -5°C/23°F).
- Do not expose the headset to rain or other liquids.

jabra.com/evolve2-30